



Audipack®

It's great to have solutions...

FACT SHEET

390771



Max. "
55

Max.
30

Quick Release
No tools required

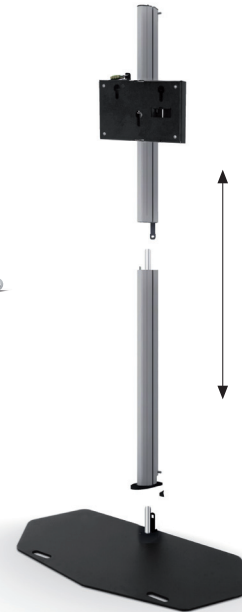

1829 mm

Single column, dividable floor stand for flat panels up to 30 Kg. No tools needed for assembling. The perfect rental product.

Single column flat panel floor stand for rental purposes. The quick release feature allows you to install the floor stand and screen on any location without tools.

The column has 3 separate cable passages allowing a separate passage of power, audio and data cables.

The presentation height of the flat panel is adjustable. This floor stand is suitable for flat panels with a maximum screen size of 55 inch, in landscape or portrait orientation.

- ▲ **No tools required for installation**
- ▲ **Integrated ruler for screen height positioning**
- ▲ **3 separate cable channels**
- ▲ **Suitable for all brands of flat panels**
- ▲ **Landscape and portrait orientation of the screen**

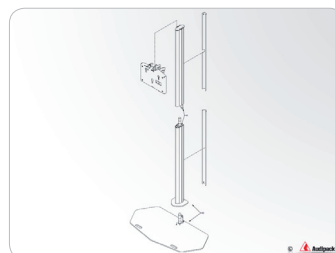



Audipack®

It's great to have solutions...

FACT SHEET

390771

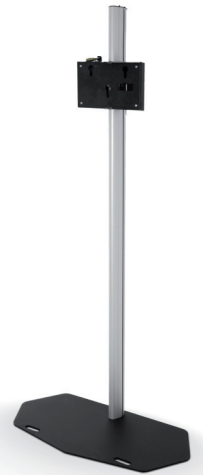
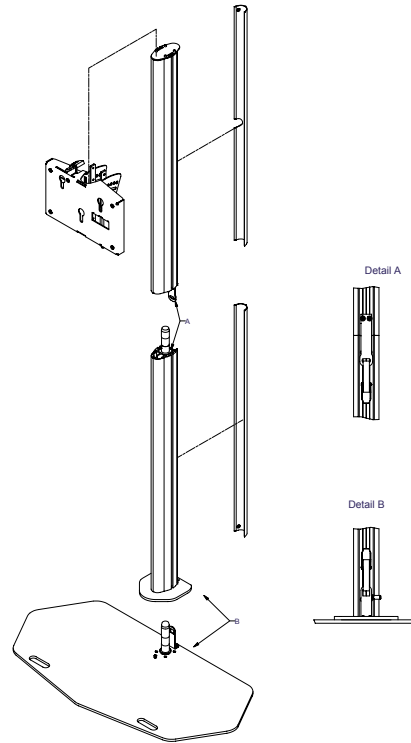
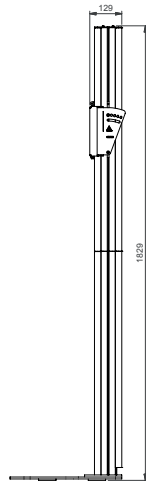
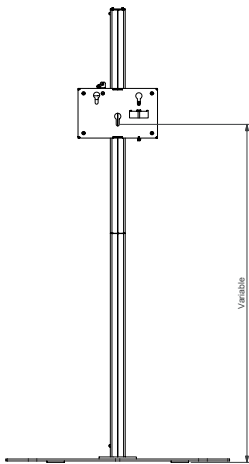
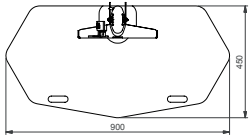

Technical specifications

Dimensions in mm	W900 x D450 x H1829
Max. screen size	55 inch
Max. load	30 Kg
Mounting interface	L&S 3
Colour	Floor plate: Black, RAL 9005 Columns: Anodised aluminium
Weight	32 Kg
Screen orientation	Landscape or Portrait

Optional

- Mounting bracket (required for screen installation)
universal models and brand related models available
- Flightcase for safe transport of the floor stand and screen
- Laptop supports, 390729, 390730
- Mounting head for multiple screen installation, 390763
- Portrait/Landscape adapter, P3496
- Lock for protect the screen against theft, 230045, 230052